

One of these digital case assemblies replaces the case assembly as drawn in the dimensional drawing. Please note that the height increases when a connector is used.

analog / RS232

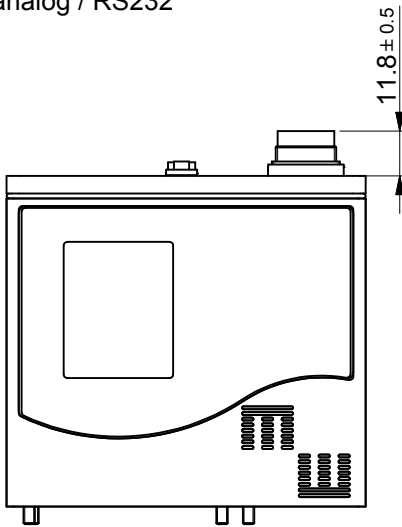

FLOW-BUS / DeviceNet / Modbus

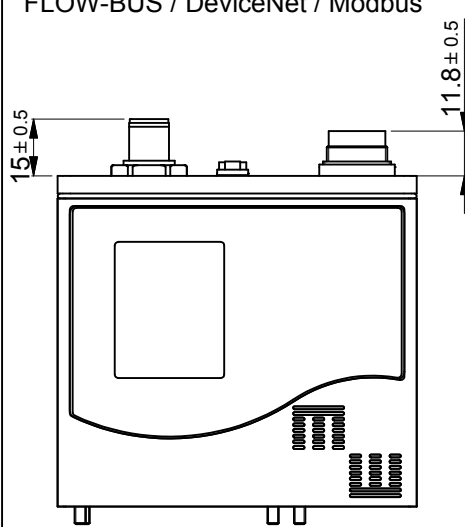

PROFIBUS

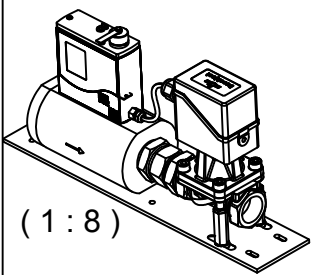
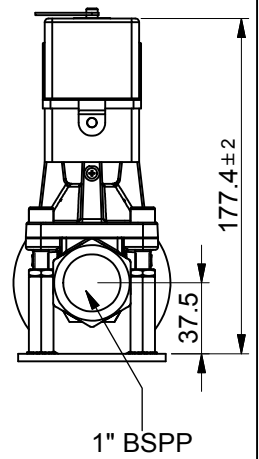
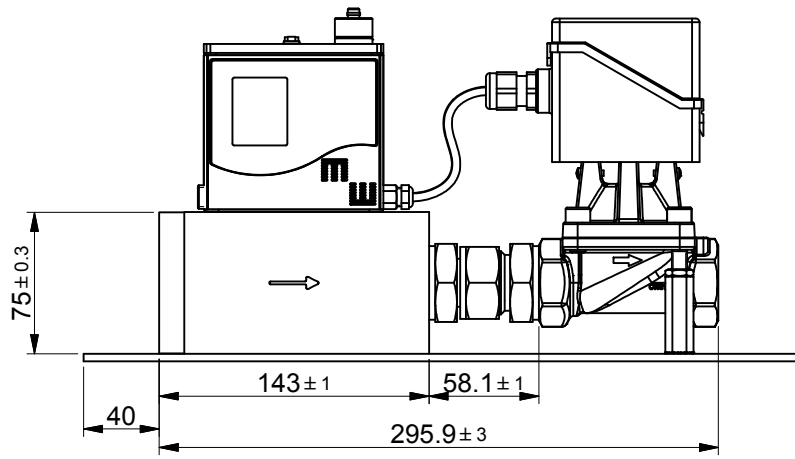
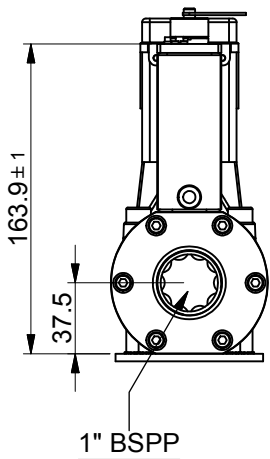
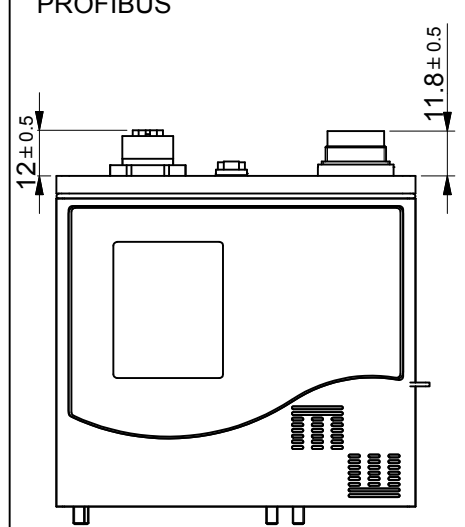

(1 : 8)

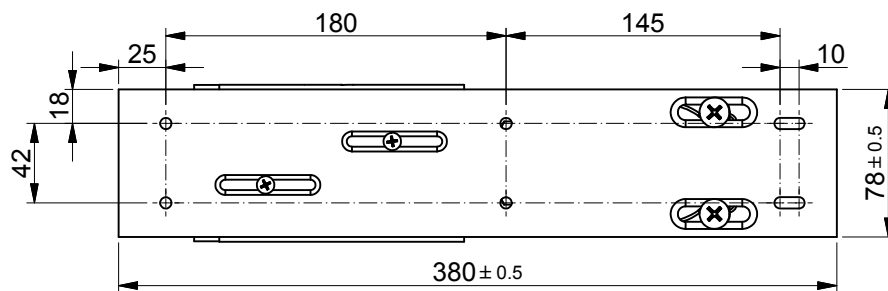

Tolerances  $\pm 0.2$  unless otherwise mentioned

Dimensions subject to change without notice.

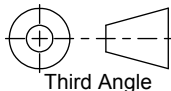
Title: <b>Dimensional drawing M+W D-6383/BJ1"</b>		Drawer: M.B. Date: 07-01-2010	Revision Description: Portconnector changed.	
 WWW.MW-INSTRUMENTS.COM	Projection:  Third Angle	Checked: J.E. Date: 10-03-2014	Rev. by: M.H.	Scale: 1:4
	Dimensions: Metric (mm)	Drawing no.: 7.05.775	Rev.: D	A4 Page: 1-1