

One of these digital case assemblies replaces the case assembly as drawn in the dimensional drawing. Please note that the height increases when a connector is used.

analog / RS232

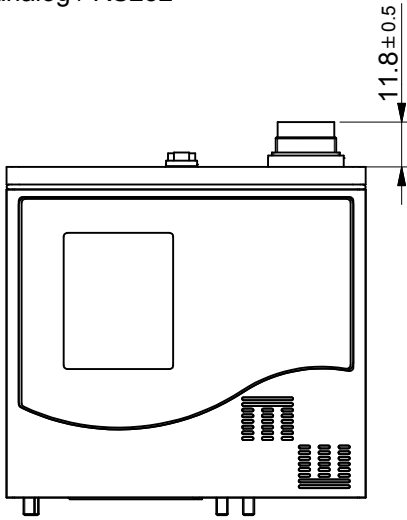

FLOW-BUS / DeviceNet / Modbus

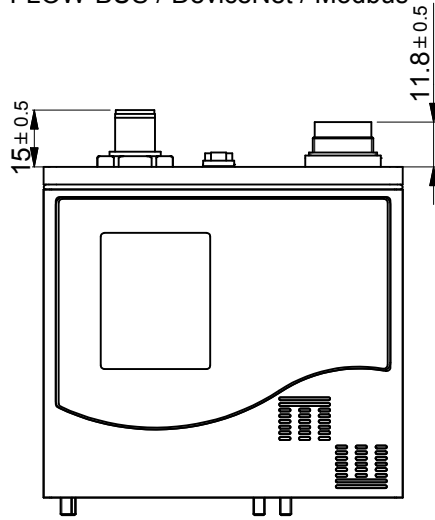

PROFIBUS

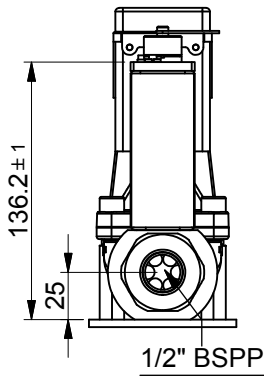
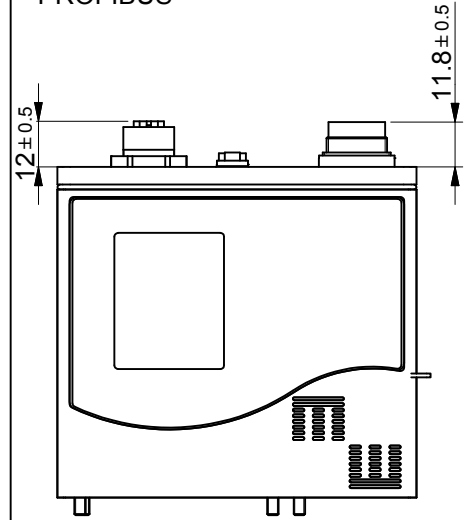

1/2" BSPP

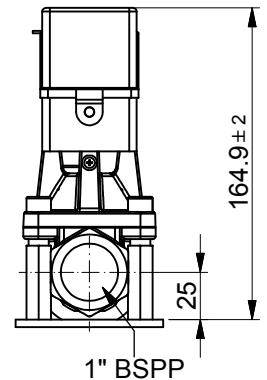
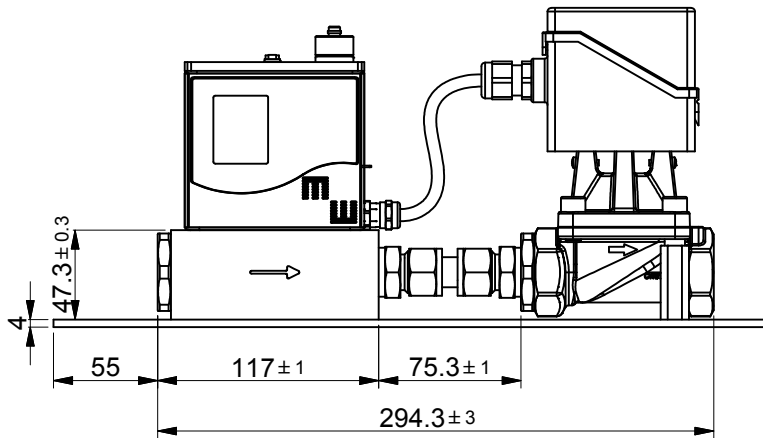

1" BSPP

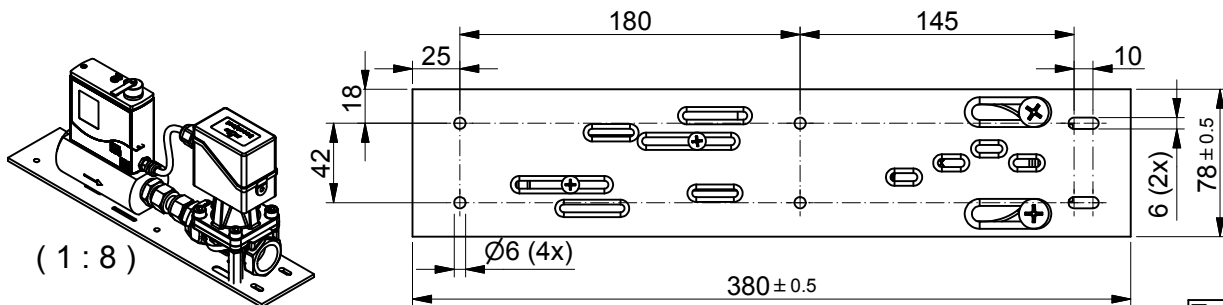

(1 : 8)

Dimensions subject to change without notice.

Tolerances ±0.2 unless otherwise mentioned

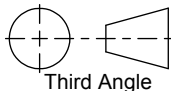
Title: <b>Dimensional drawing M+W D-6373 / BJ 1"</b>		Drawer: M.B. Date: 07-01-2010	Revision Description: Portconnector changed.	
 WWW.MW-INSTRUMENTS.COM	Projection:  Third Angle	Checked: J.E. Date: 07-03-2014	Rev. by: M.H.	Scale: 1:4
	Dimensions: <b>Metric (mm)</b>	Drawing no.: 7.05.782	Rev.: E	A4 Page: 1-1