

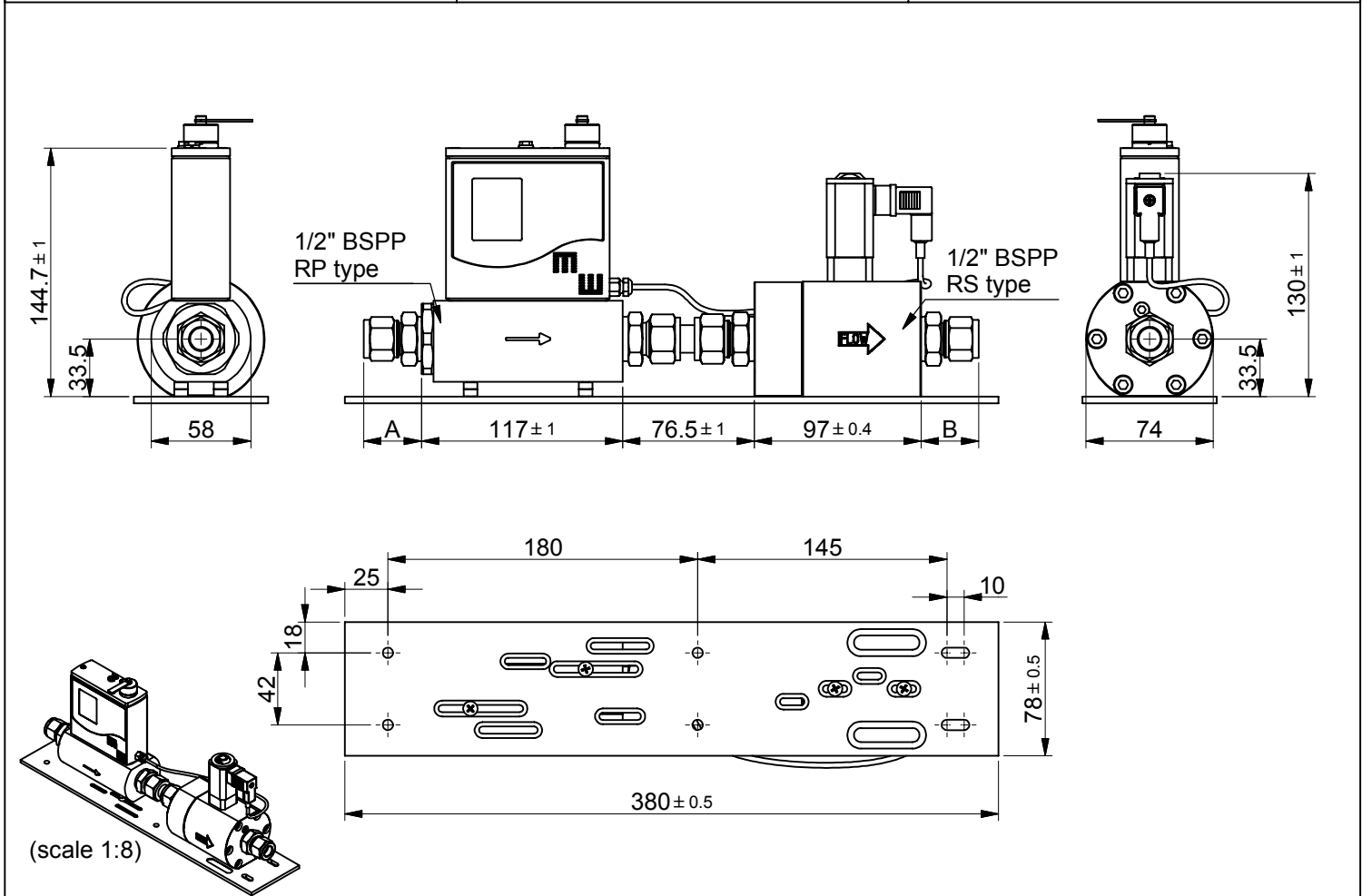

One of these digital case assemblies replaces the case assembly as drawn in the dimensional drawing.
Please note that the height increases when a connector is used.

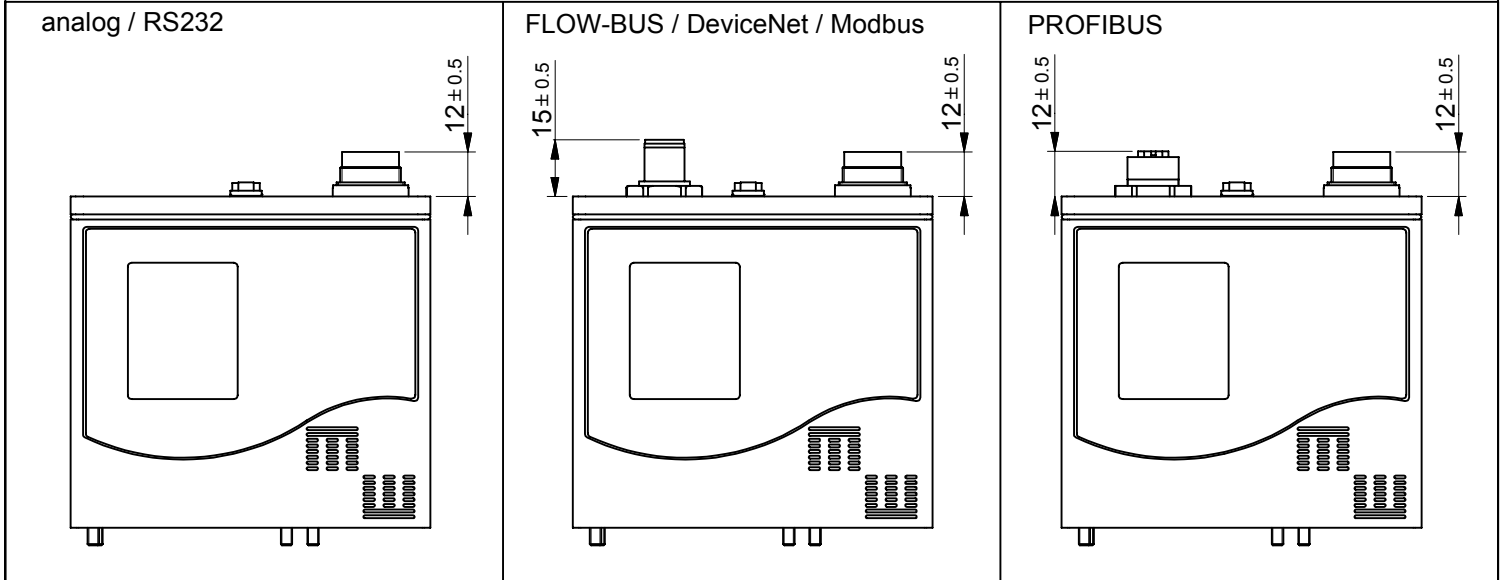

Check document 7.05.306 for dimension A.
Check document 7.15.117 for dimension B.
Dimensions subject to change without notice.

Tolerances ± 0.2 unless otherwise mentioned

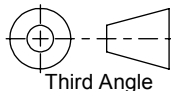
Title: Dimensional drawing M+W D-6373 / F-003AI		Drawer : M.d.J. Date: 08-07-2014	Revision Description: New drawing	
 WWW.MW-INSTRUMENTS.COM	Projection:  Third Angle	Checked : J.E. Date: 01-12-2014	Rev. by:	Scale: 1:4
	Dimensions: Metric (mm)	Drawing no.: 7.05.907	Rev.: A	A4 Page: 1-1